

AquaTronics[®]

OWNER'S MANUAL
AND
INSTALLATION GUIDE

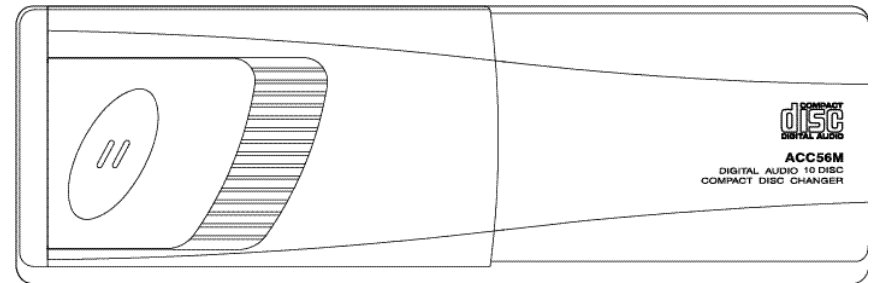

ACC56M

10-DISC CD CHANGER

ASA
The Mobile Electronics Company
AUDIOVOX SPECIALIZED APPLICATIONS,LLC
www.asaelectronics.com

Visit us at www.asaelectronics.com to see our full line of mobile audio and video products.

MADE IN CHINA

INTRODUCTION

Congratulations on your purchase of the **AQUATRONICS ACC56M REMOTE-CONTROL 10-DISC CD CHANGER**.

This system allows you to easily upgrade your existing audio system to include a quality CD entertainment function. Best of all, the CD Changer is easy to install. There is only one cable to plug in to the rear of the already equipped radio. Just follow the simple step-by-step instructions that follow.

FEATURES

Remote mount changer holds up to 10 compact discs.

Advanced technology includes 8x oversampling digital filter and twin 1-bit digital/analog converters

The special design allows horizontal, vertical or 45-degree mounting.

Designed to work with Aquatronics and Voyager CDC ready radios.

INDEX

Introduction and Contents	page 1	Hints for Correct and Safe Operation	page 10
Packing List	page 2	Handling the Discs	page 11
Before Installing the Unit Page	page 3	Use of the CD Magazine	page 12
Where to Install the Changer	page 4	Specifications	page 14
Installation	page 5	Troubleshooting	page 15
Overall Wiring View	page 9		

PACKING LIST

Main Unit

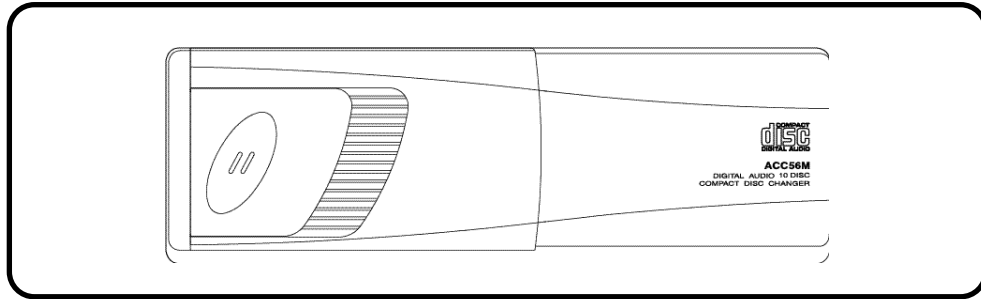

Installation Parts

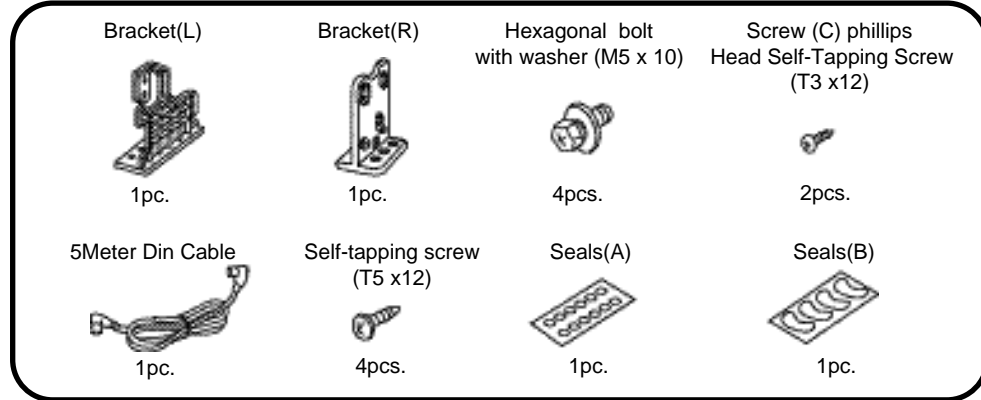

Other Accessories

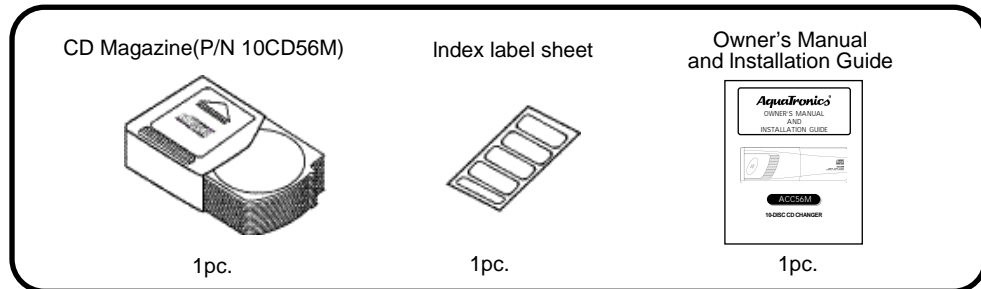

BEFORE INSTALLING THE UNIT

Transport Lock Screws

The mechanism in the CD changer is "locked" into place during shipment by three transport lock screws. Be sure to remove the screws prior to installation.

CAUTION: After removing the transport lock screws, place the supplied seals (A) over the screw holes. These seals are used to keep dust out of the unit, which could cause a malfunction.

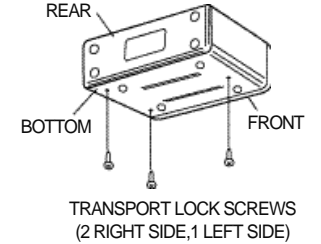

Installation and Wiring Precautions

- To prevent a short-circuit, Be sure to turn off the ignition and remove the negative (-) battery cable, prior to installation. Connect power wires last.

NOTE: If the changer is to be installed in a vehicle that is equipped with an on-board drive or navigation computer, do not disconnect the battery cable. If the cable is disconnected, the computer memory may be lost. Under these conditions, use extra caution during installation not to cause a short circuit.

- Do not install the unit in the following locations.
Locations exposed to direct sunlight.
Where hot air is discharged from the car heater.
In areas subject to extreme temperatures.



- Incorrect installation can cause the disc to skip when playing. Be sure to mount the unit firmly in place, using the supplied brackets and screws.
- Be sure to use the supplied screws. Be careful not to snag any wires when tightening screws. Be careful not to damage the vehicle wiring.
- This unit cannot be installed on its side, end, or upside down. Installation in such positions will cause malfunctioning of the mechanism.

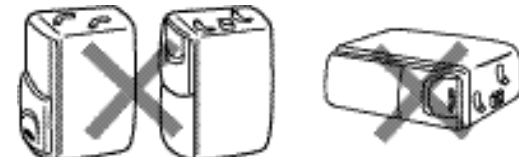

WHERE TO INSTALL THE CHANGER

A few of the many mounting possibilities are shown below. The following precautions must be considered when selecting the mounting location.

Installation Cautions and Warnings:

1. Fuel Tank - **WARNING!** Never install above your fuel tank as the holes you must drill may pierce the tank or the fuel lines. Also check for other obstructions such as wires, etc.
2. Excessive Heat - Avoid areas exposed to direct sunlight.
3. Ease of Use - Make certain the changer is easily accessible for loading and unloading the CD magazine.
4. Distance - The data cable that joins the changer to your existing CDC ready radio is 15 feet long. Do not exceed this length.
5. If mounting to a plastic surface, do not use the self-tapping screws provided. Use the bolts and hex nuts provided for a more secure installation.

IMPORTANT: Failure to properly secure the CD changer is the most common cause of "skipping" and related CD play problems.
Changer must be mounted as explained on the following pages.

INSTALLATION

The ACC56M changer is designed for horizontal (flat), vertical (upright) or 45-degree mounting. It must never be mounted upside-down or on either one of its sides as explained previously. The position of the built-in anti-vibration springs (left and right side), must correspond to the mounting position chosen. If the springs are not set correctly for the type of installation chosen, the anti-vibration compensation will not be effective and vibration may cause the disc to skip.

CAUTION: After setting the built-in anti-vibration springs, place the supplied Seals (B) over the holes. These seals are used to keep dust, which could cause a malfunction, out of the unit.

HORIZONTAL INSTALLATION

Set the 4 anti-vibration springs to position " H "

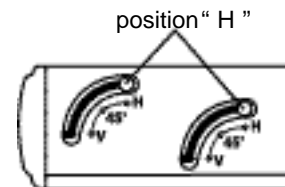

45° ANGLE INSTALLATION

Set the 4 anti-vibration springs to position " 45. "

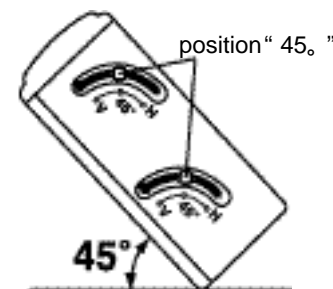

VERTICAL INSTALLATION

Set the 4 anti-vibration springs to position " V "

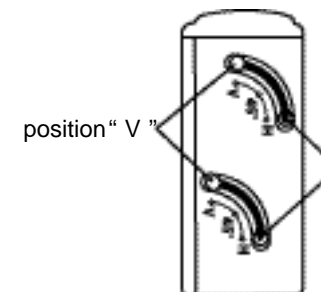

PROCEDURE FOR HORIZONTAL INSTALLATION

Attach bracket (L) and bracket (R) to each side of the unit, using the hexagonal bolts with washer base (M5 x 10).



Anti-vibration springs position

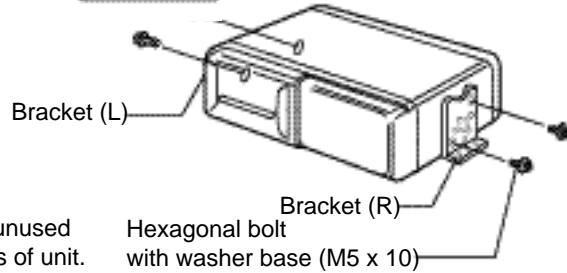

NOTE: Use seals (A) to cover unused mounting holes on sides of unit.

Hexagonal bolt with washer base (M5 x 10)

Determine the mounting location, and drill four mounting holes.

Never mount the unit near the fuel tank.

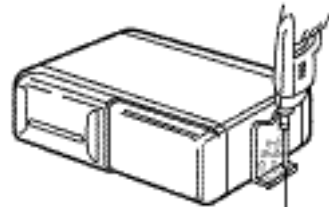

Drill holes 4mm in diameter.

Secure the unit in place, using four self-tapping screws (T5 x 12).

Use RTV (silicone sealer) on screw threads or around the holes to prevent moisture intrusion.

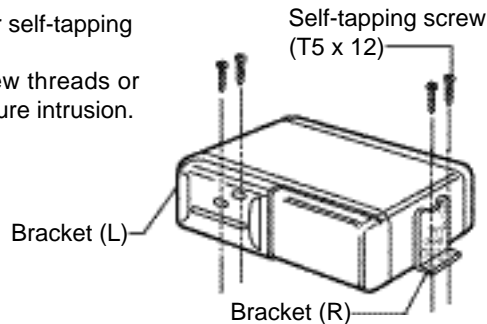

PROCEDURE FOR VERTICAL INSTALLATION

NOTE: If the anti-vibration spring position has been changed and verified for vertical mounting (as shown on page 6), start with step 2.

Set the 4 anti-vibration springs to position "V"

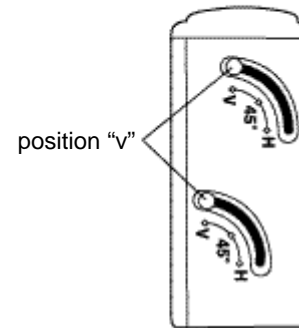

Attach bracket (L) and bracket (R) to each side of the unit, using the hexagonal bolts with washer base (M5 x 10).

NOTE: Use seals (A) to cover unused mounting holes on sides of unit.

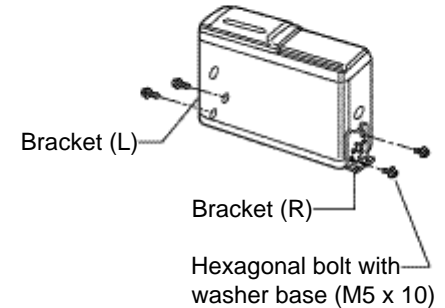

Determine the mounting location, and drill four mounting holes.

Mount the unit in place, using four self-tapping screws (T5 x 12). Use RTV (silicone sealer) on screw threads or around the holes to prevent moisture intrusion.

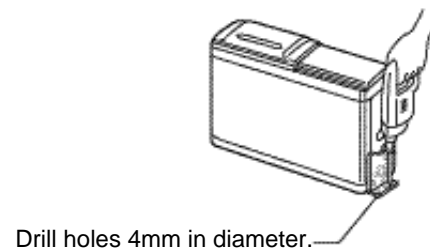

Drill holes 4mm in diameter.

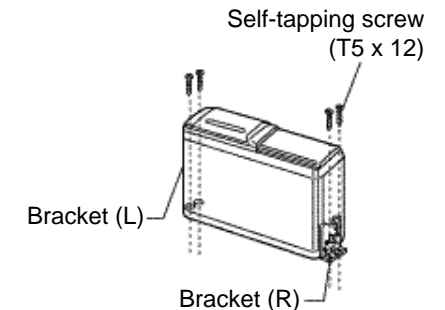

PROCEDURE FOR 45° ANGLE INSTALLATION

NOTE: If the anti-vibration spring position has been changed and verified for 45° angle mounting (as shown on page 6), start with step 2.

Set the 4 anti-vibration springs to position "45°"

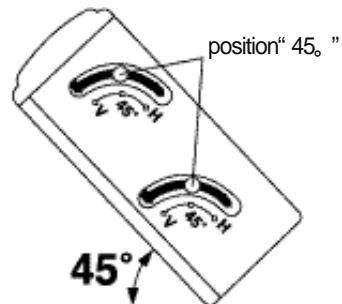

Attach bracket (L) and bracket (R) to each side of the unit, using the hexagonal bolts with washer base (M5 x 10).

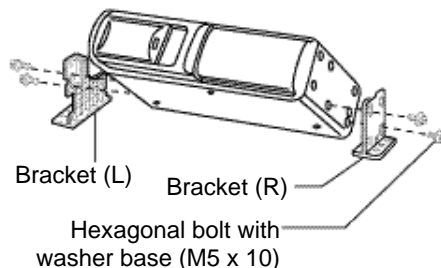

Determine the mounting location, and drill four mounting holes.

Never mount the unit near the fuel tank.

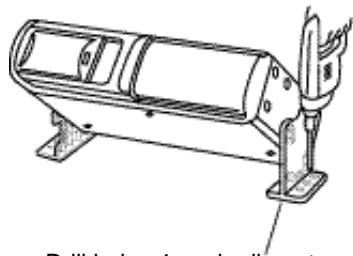

Drill holes 4mm in diameter.

Mount the unit in place, using four self-tapping screws (T5 x 12). Use RTV (silicone sealer) on screw threads or around the holes to prevent moisture intrusion.

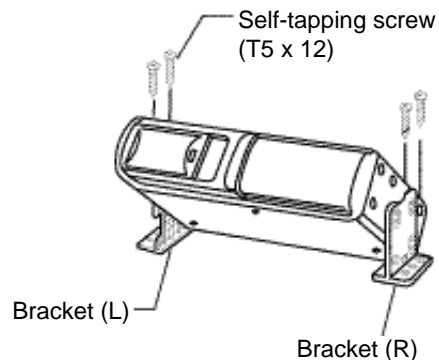

OVERALL WIRING VIEW

This page is provided to give you a quick look at the entire wiring of the ACC56M. Use it to plan your wire routing paths and possible connection points. Detailed wiring is explained in the following pages.

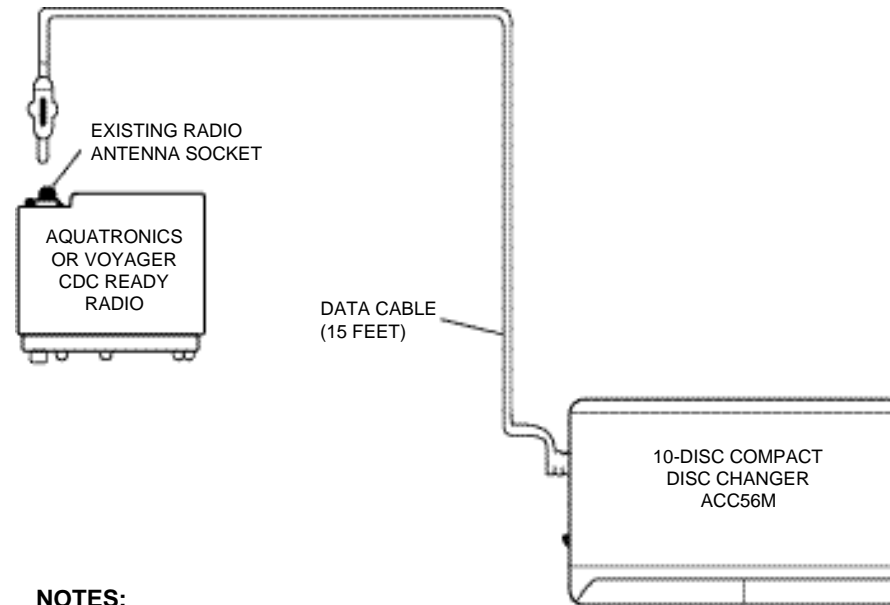
**NOTES:**

When routing wires and cables from the changer to the radio, it is best to conceal the wires.

It may be necessary to press the RESET button on the face of the radio the first time after the ACC56M is installed.

This will cause the radio to "recognize" that the ACC56M is connected.

HINTS FOR CORRECT AND SAFE OPERATION

This CD Changer is designed to be operated only on 12 volt DC negative ground systems. The unit cannot be used on 24 volt or positive ground systems.

Temperature

The unit may not operate correctly in extremely hot or cold temperatures. It is equipped with a built-in thermal protection circuit which will stop operation of the unit when the temperature reaches the preset level. If this should happen, the unit will resume operation when the vehicle returns to a normal temperature range. Remove the magazine from the unit when it is not being used during hot weather. If the CD changer is not used for long periods of time, remove the compact discs from the magazine, and store them in their cases.

Condensation

Moisture can condense on the laser lens of the CD changer during rainy and humid days, If this should happen the unit will not operate correctly. To remedy the situation, remove the discs from the unit and wait approximately one hour. During this time the moisture will evaporate and the unit will operate normally.

Interruptions in sound(Skipping)

The sound from the unit may "skip" and be interrupted if the anti-vibration springs are not set correctly, if the changer is mounted on-end or upside-down, or when travelling on very rough surfaces. If this should occur, check for errors made during installation or wait for the surface to improve.

3"(8 cm) CD-Singles

This unit is not designed to play 3" (8cm) CD-Single discs. Inserting a 3" disc into the magazine, either with or without a 3" disc adaptor, can damage the changer and the disc. Such damage will not be covered by the Warranty on this product.

HANDLING THE DISCS

Dirt, dust, scratches and warpage cause sound skips during playback and a deterioration of sound quality. To take proper care of your discs:

1. Use compact discs that have the  logo.
2. Fingerprints and dust should be carefully wiped off the disc's signal surface (glossy side) with a soft cloth. Unlike conventional records, the compact disc has no grooves to collect dust and microscopic debris, so gently wiping with a soft cloth should remove most particles. Wipe in a straight motion from the inside to the outside of the disc. Small dust particles or light stains will have absolutely no effect on reproduction quality.
3. Never use such chemicals as record sprays, antistatic sprays or fluids, benzine or thinner to clean compact discs. Such chemicals could irreparably damage the disc's plastic surface.
4. Discs should be put back in their cases after use to avoid serious scratches that could cause the sound to skip.
5. Do not expose discs to direct sunlight, high humidity, or high temperatures for extended periods of time. Long exposure to high temperatures can warp the disc.
6. Do not stick paper, labels, or tape on the disc surface.
7. Do not write with any type of pen, pencil, or marker on the disc surface.
8. To minimize fingerprints and smudges on the signal surface, always try to hold the discs by their outer edge and center hole.

USE OF THE CD MAGAZINE

Loading Disc Into The Magazine

This CD Changer uses a specially-designed magazine to hold up to 10 compact discs. To load discs into the magazine, grip the tab on the magazine tray into which you will be loading a disc and pull it out gently as shown in Figure 1. Pull out only one tray at a time. Insert a disc into the tray with the label side down (play surface facing up) as shown in Figure 2. Push the tray back into the magazine as shown in Figure 3. Load discs into the remaining 9 trays in a similar manner.

Fig. 1

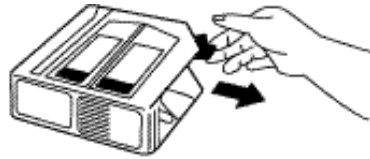

Fig. 2

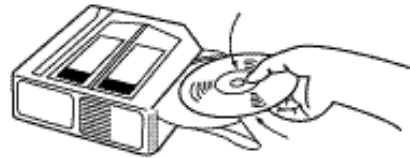

Fig. 3



Removing Discs From The Magazine

To remove a disc from the magazine, pull out the tray of the disc to be removed, lift out the disc, and push the tray back into the magazine.

NOTES :

Avoid touching the playing side of the disc.

Only one disc can be inserted into each tray of the magazine. Do not try to insert more than one disc into each tray as damage to the discs and magazine may occur.

This changer is not designed to play 3" CD-5 Single discs (8cm). Inserting a 3" disc into the magazine, either with or without a 3" disc adaptor, can damage the changer and the disc. Such damage will not be covered by the Warranty on this product.

For additional CD magazines, you may contact us at www.asaelectronics.com

Loading The Magazine Into The Changer

Completely slide the door on the changer to the right as shown in Figure 4. Making sure the top of the magazine is facing upward, gently insert it into the unit until it clicks into place, as shown in Figure 5. Slide the door of the changer fully closed and the unit is ready for operation.

Fig. 4

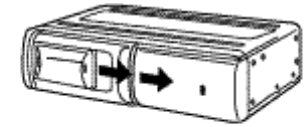

Removing The Magazine From The Changer

The magazine can be removed from the changer using one of two methods as outlined below in steps 1 and 2.

NOTE: Be sure to keep the door on the changer closed at all times when not loading or removing the magazine. Leaving the door open could allow dust, dirt and moisture to enter the changer which could cause the unit to malfunction.

1. During normal operation with power applied, slide open the door on the changer and press the eject button as shown in Figure 6. The magazine will eject and can be removed.

2. If the magazine will not eject in a normal manner, remove power by disconnecting the DIN cable from the changer.

a. Slide open the magazine door. On the bottom left rear of the changer, as shown in Figure 5, peel off the tape covering the access hole; insert a thin-bladed screwdriver into the access hole and engage the mechanical release arm.

b. Lightly leverage the blade to the right and the magazine will disengage and be ejected.

Fig. 5

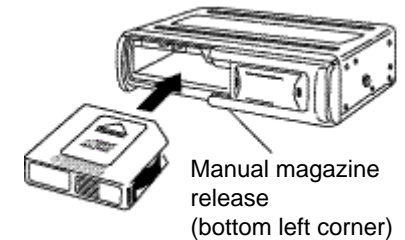
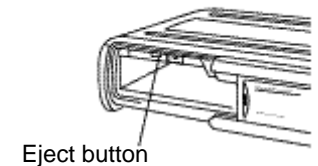

Fig. 6



SPECIFICATIONS

Changer

Frequency Response	5 - 20,000 Hz \pm 1dB
Distortion	0.008% @ 1kHz
Dynamic Range	95 dB
Signal-to-Noise Ratio	95 dB
Channel Separation.....	70 dB @ 1kHz
Wow & Flutter	below measurable limits
Dimensions	(W) 9-6/8" x (H) 3-2/8" x(D) 7-1/8"
	(W)250 mm x (H)81 mm x (D)181 mm
Operating Voltage	12 Volts DC, negative ground
Current Drain	800mA (Playback/loading/ejecting)
Accessories Supplied:	10-disc magazine, P/N 10CD56M
	Mounting hardware (1set)
	Connecting cable (1ea.)

TROUBLESHOOTING

An error made in operation or during installation of this product may be mistaken for a system malfunction. Please perform the checks described below before contacting your dealer or service facility.

Symptom	Possible Cause	Remedy
No power	Blown fuse	Check fuses in vehicle fuse box and changer system. Replace as necessary with fuse of same type and rating as original. If fuse blows again, consult with service facility.
	Incorrect connection	Check all wiring and correct as necessary.
Magazine cannot be installed	Magazine is inserted in wrong direction.	Insert magazine in proper direction.
CD is not played	Disc is located incorrectly in magazine	Load disc correctly in the magazine.
Noise, Skipping, or intermittent sound during playback	Scratches on disc or warped disc	Check sound on another disc. If sound from second disc is OK, first disc is defective.
	Extremely dirty disc	Clean disc
	Transit screws still in place	Remove the transit screws from sides of the unit.
	Mounting angle adjustment is not correct.	Set the mounting angle adjustment to the correct position as per the installation instructions.
Radio will not switch to CDC mode	Radio has not been initialized with the ACC56M attached	Press the RESET button on the face of the radio.



The Mobile Electronics Company

AUDIOVOX SPECIALIZED APPLICATIONS, LLC

90 DAY/12 MONTH LIMITED WARRANTY

AUDIOVOX SPECIALIZED APPLICATION, LLC. (The Company) warrants to the original retail purchaser of this product that should this product or any part thereof, under normal use and conditions, be proven defective in material or workmanship within 90 day from the date of original purchase, such defect(s) will be repaired or replaced (at the Company's option) without charge for parts and repair labor. After the initial 90 days period and for a period of 12 months from the date of original purchase, the Company will supply at no charge a replacement for any defective part(s) but will charge for the labor to repair the product.

To obtain repair or replacement within the terms of this Warranty, ASA must be called and a Return Authorization will be given to reference the product when returned. The product is to be delivered with proof of warranty coverage (e.g. Dated bill of sale), specification of defect(s), transportation prepaid, and with the Return Authorization Number clearly written on the outside of the package. The product must be returned to ASA for repair unless specified otherwise by ASA.

This Warranty does not cover the elimination of externally generated static or noise, to the correction of antenna problems, to costs incurred for removal or reinstallation of the product, or to damage to any tapes, speakers, accessories, or electrical Systems.

This Warranty does not apply to any product or part thereof which in the opinion of the Company has been damaged through alteration, improper installation, mishandling, misuse, neglect, or accident. THE EXTENT OF THE COMPANY'S LIABILITY UNDER THIS WARRANTY IS LIMITED TO THE REPAIR OR REPLACEMENT PROVIDED ABOVE AND, IN NO EVENT, SHALL THE COMPANY'S LIABILITY EXCEED THE PURCHASE PRICE PAID BY PURCHASE FOR THE PRODUCT.

This Warranty is in lieu of all other express warranties or liabilities, ANY IMPLIED WARRANTIES, INCLUDING ANY IMPLIED WARRANTY OF MERCHANTABILITY, SHALL BE LIMITED TO THE DURATION OF THIS WARRANTY. ANY ACTION OR ANY BREACH OF ANY WARRANTY HEREUNDER INCLUDING ANY IMPLIED WARRANTY OF MERCHANTABILITY MUST BE BROUGHT WITHIN A PERIOD OF 30 DAYS FROM DATE OF ORIGINAL PURCHASE. IN NO CASE SHALL THE COMPANY BE LIABLE FOR ANY CONSEQUENTIAL OR INCIDENTAL DAMAGES OR BREACH OF THIS OR ANY OTHER WARRANTY. EXPRESS OR IMPLIED, WHATSOEVER. NO person or representative is authorized to assume for the Company any liability other than expressed herein connection with the sale of this product. Some states do not allow limitations on how long an implied warranty lasts or the exclusion of incidental or consequential damages so the above limitations or exclusions may not apply to you. This Warranty gives you specific legal rights and you may also have other rights which vary from state to state.

AUDIOVOX SPECIALIZED APPLICATIONS, LLC
www.asaelectronics.com